

Spring Appendix



Advancing the Practical Application of Suspension Technology

Springfield, MO ■ (800) 654-8824 ■ (417) 862-5012
Fax (417) 862-2317 ■ www.hutchensindustries.com

Spring Appendix

General Information

1. A Hutchens part number is stamped on all of the steel springs that we supply. For springs with clips, our part number is stamped on the outside of the spring clip. On springs without clips and with hooks, our part number is stamped on the outside of the hook. All other springs are stamped in a visible location on one of the spring leaves.
2. All springs for the 440 and 900 single point suspensions are 5" wide. The 11436-00 and 22429-01 springs are 4" wide. All other springs are 3" wide.
3. The Gross Axle Weight Rating (GAWR) or Gross Tandem Weight Rating (GTWR) is listed for each spring.
4. Weights given are per spring.
5. Deflection charts are per spring NOT per axle.
6. H.D. (Heavy Duty) springs are recommended for widespread applications.
7. Single leaf springs are NOT recommended for tri-axle applications.



20488-01 3 Leaf

GTWR 44,000 lbs.

Weight 217 lbs.

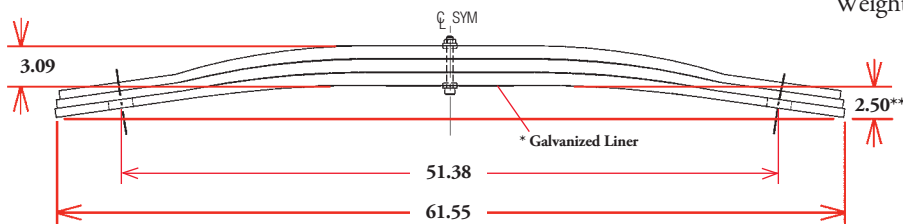

24955-01 5 Leaf

GTWR 44,000 lbs.

Weight 266 lbs.

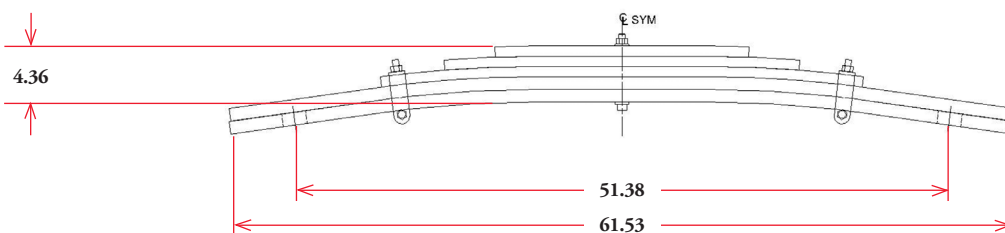

* Galvanized liner required on the tension surface of spring when installed.

** Arch with no load.



9997-00 6 Leaf GTWR 42,000 lbs.

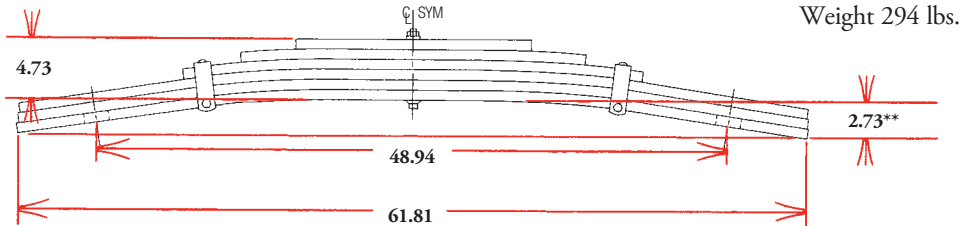

9998-00 6 Leaf GTWR 42,000 lbs.

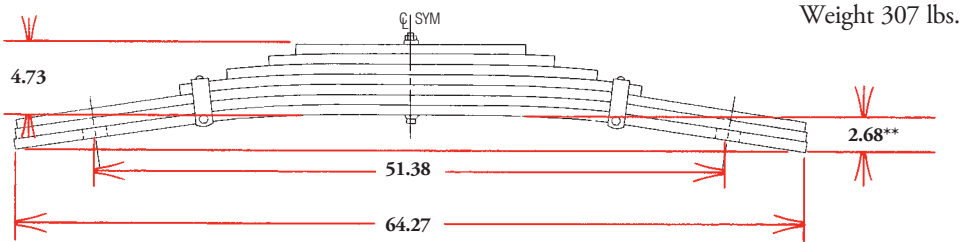

9999-00 7 Leaf GTWR 50,000 lbs.

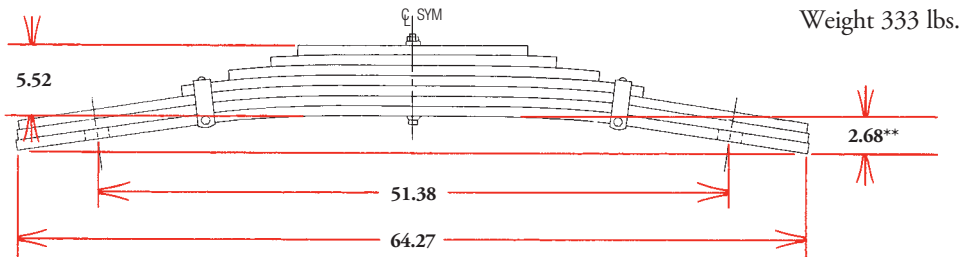

10000-00 8 Leaf GTWR 50,000 lbs.

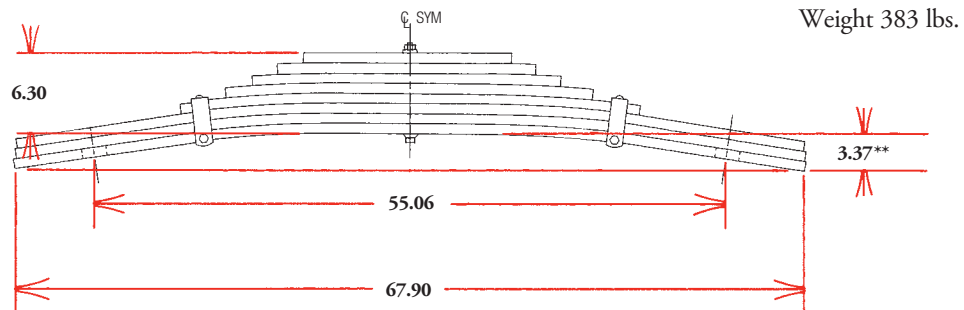

** Arch with no load.

Spring Appendix

10001-00 9 Leaf

GTWR 60,000 lbs.

Weight 410 lbs.

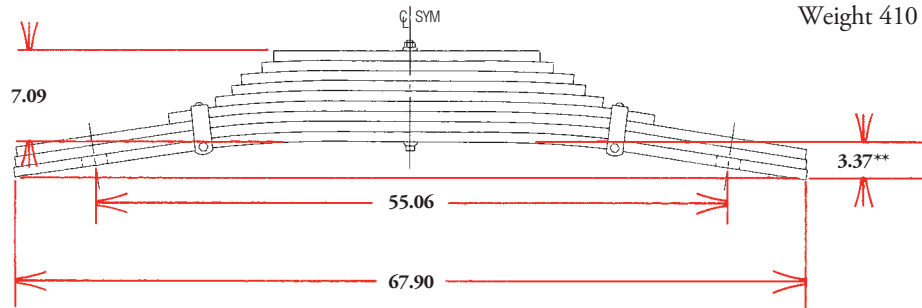

10054-00 5 Leaf

GTWR 36,000 lbs.

Weight 227 lbs.

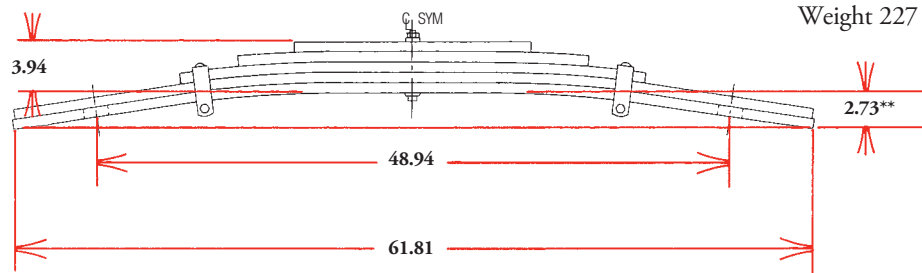

10055-00 7 Leaf

GTWR 50,000 lbs.

Weight 315 lbs.

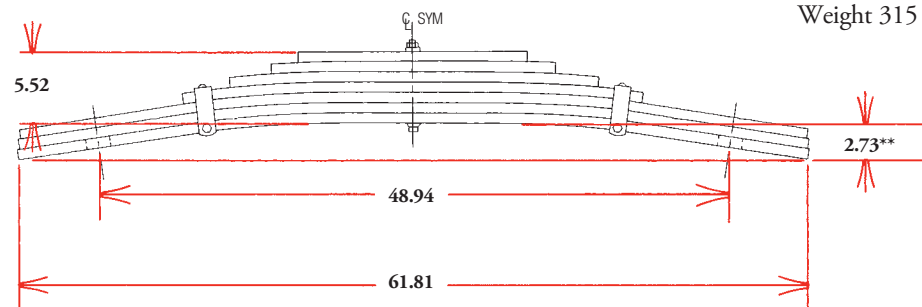

11151-00 5 Leaf

GTWR 36,000 lbs.

Weight 236 lbs.

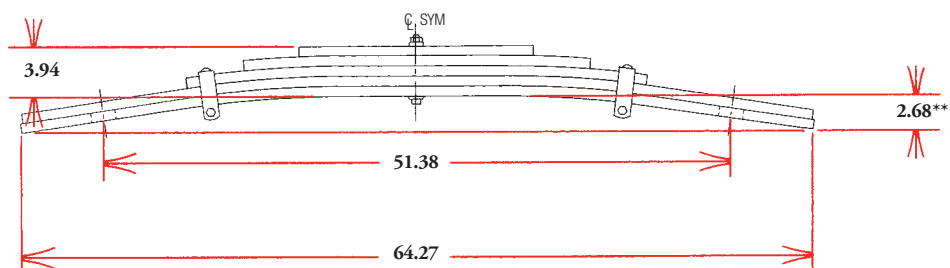

** Arch with no load.

12258-01 3 Leaf

GTWR 50,000 lbs.

Weight 240 lbs.

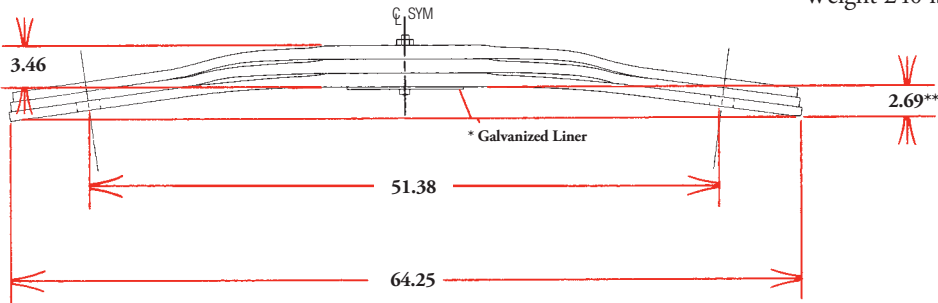

16258-01 2 Leaf

GTWR 36,000 lbs.

Weight 160 lbs.

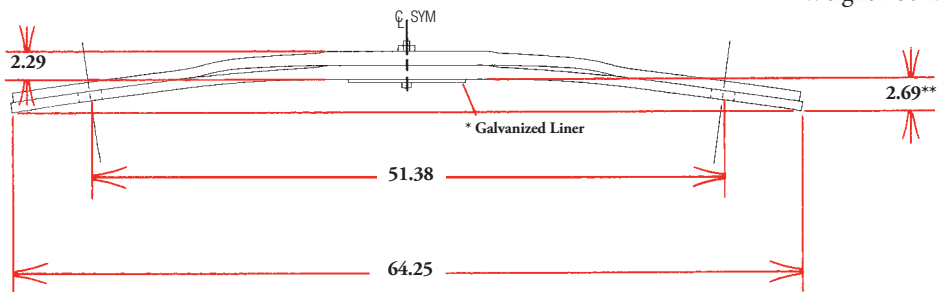

24967-01 10 Leaf

GTWR 70,000 lbs.

Weight 440 lbs.

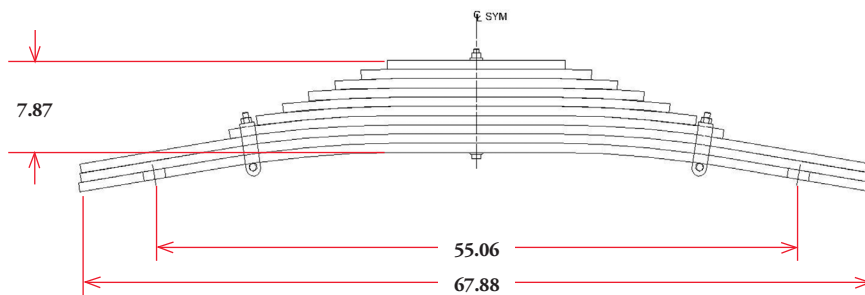

25694-01 5 Leaf

GTWR 25,000 lbs.

Weight 206 lbs.

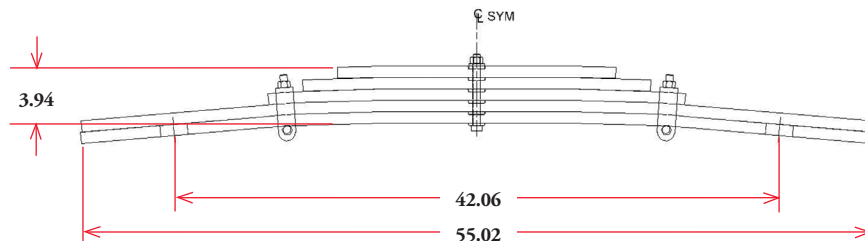

* Galvanized liner required on the tension surface of spring when installed.

** Arch with no load.

Spring Appendix

2300



2252-00 8 Leaf, 2300 Suspension

GAWR 24,000 lbs.

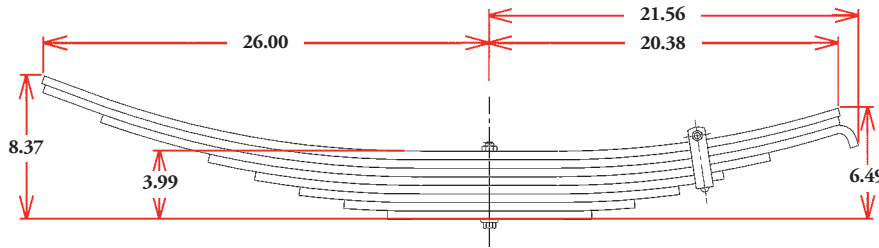

Weight 103 lbs.

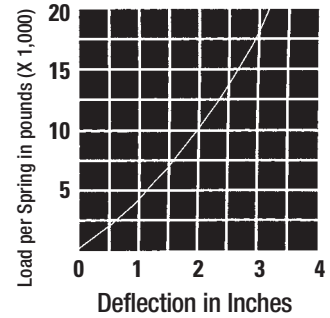

9600-9700



Single, Two and Three Leaf Spring Orientation

Unless otherwise noted, the spring hook (the long hook if the spring has a hook on each end) should be positioned as follows:

- ▶ Single Axle – Hook to rear.
- ▶ Tandem Axle (All axle centers) – Hook in rocker on both axles.
- ▶ Multi-Axle (All axle centers) – Hook to rear on the front axle, and hook forward on the remaining axles.

7051-42 Low Arch, Single Leaf

GAWR 22,400 lbs.

42 1/2" & 44" Axle Center All Positions. Long Hook to Rear on All Axles.

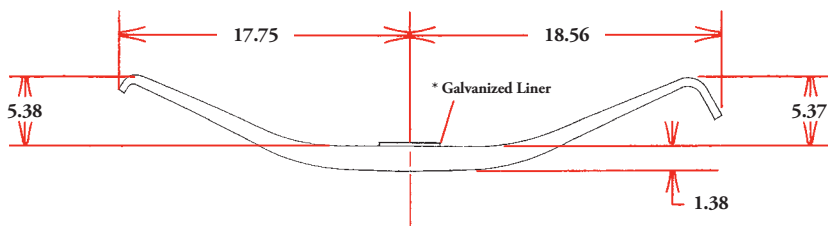

Weight 30 lbs.

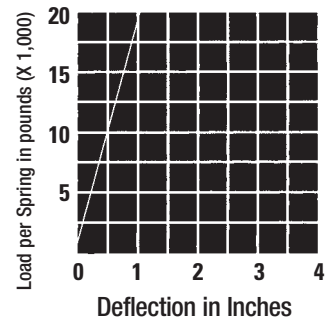

* A galvanized liner is required on the tension side of each plate on single, two and three leaf springs. On single leaf springs the spring liner is shipped loose by Hutchens.

751-04 Low Arch, 6 Leaf

42 1/2" & 44" Axle Center All Positions. Hook to Rear.

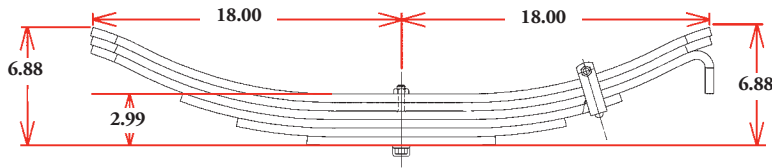

GAWR 22,400 lbs.

Weight 72 lbs.

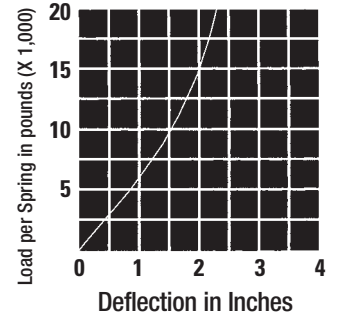

363-00 Low Arch, Single Leaf

GAWR 22,400 lbs.

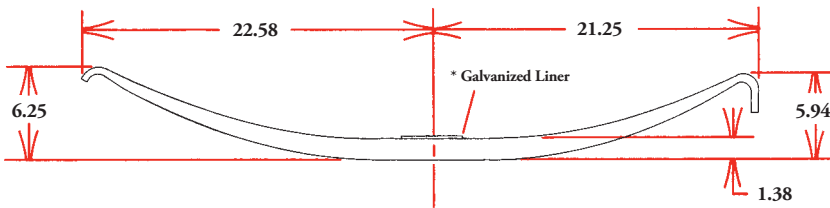

Weight 34 lbs.

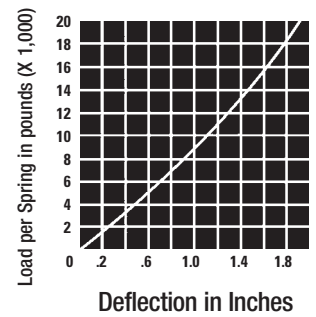

324-01 High Arch, 2 Leaf

GAWR 22,400 lbs.

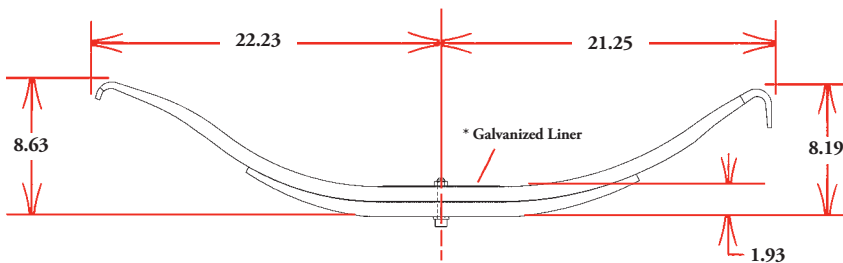

Weight 48 lbs.

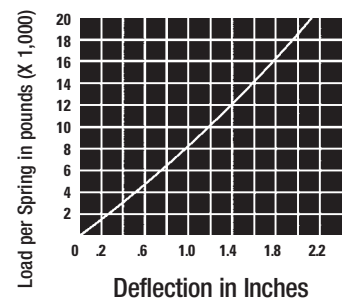

* A galvanized liner is required on the tension side of each plate on single, two and three leaf springs. On single leaf springs the spring liner is shipped loose by Hutchens.

Spring Appendix

325-01 Medium Arch, 2 Leaf

GAWR 22,400 lbs.

Weight 46 lbs.

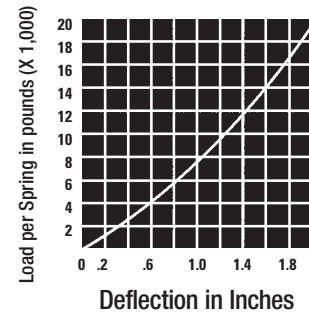
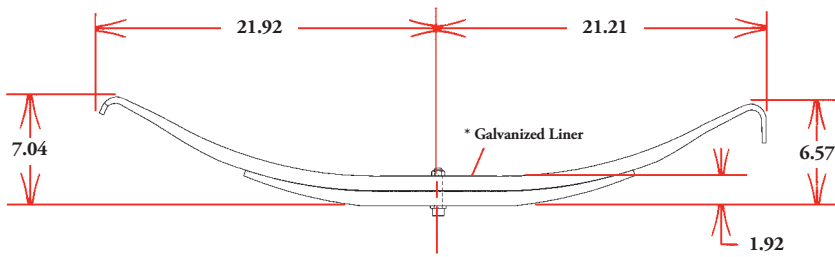

326-01 Low Arch, 2 Leaf

GAWR 22,400 lbs.

Weight 46 lbs.

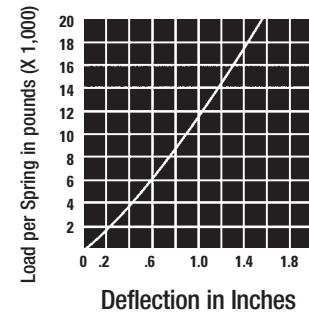
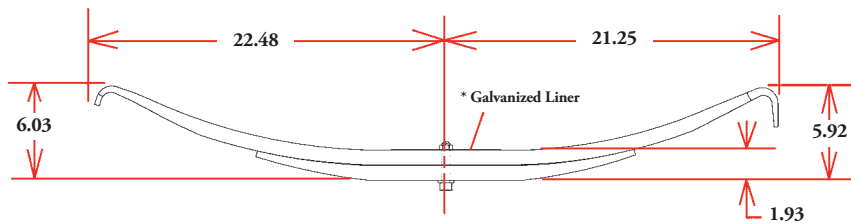

354-00 High Arch, 3 Leaf

GAWR 22,400 lbs.

Weight 53 lbs.

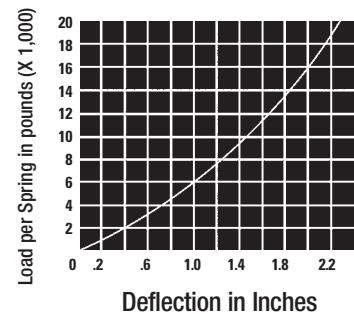
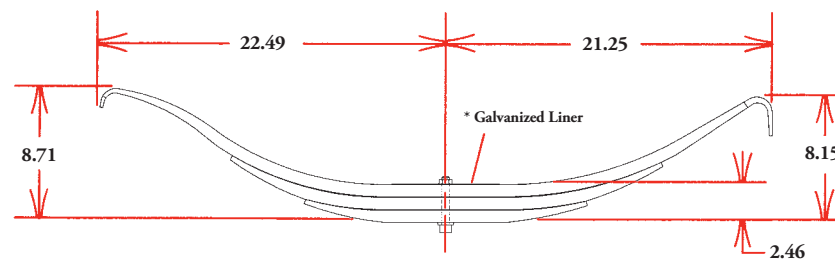

* A galvanized liner is required on the tension side of each plate on single, two and three leaf springs. On single leaf springs the spring liner is shipped loose by Hutchens.

355-00 Medium Arch, 3 Leaf

GAWR 22,400 lbs.

Weight 52 lbs.

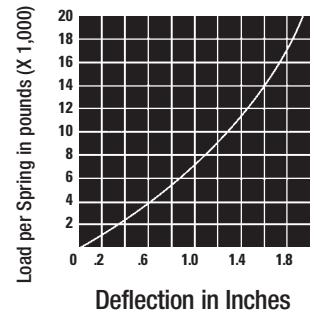
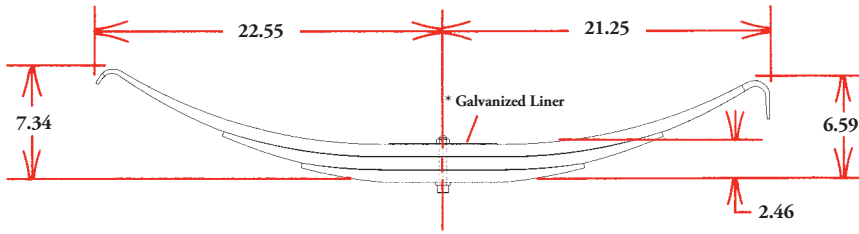

356-00 Low Arch, 3 Leaf

GAWR 22,400 lbs.

Weight 52 lbs.

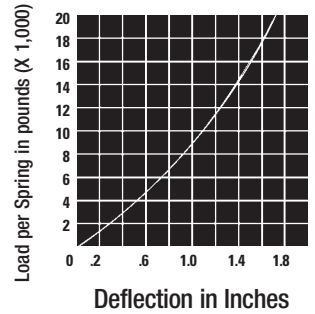
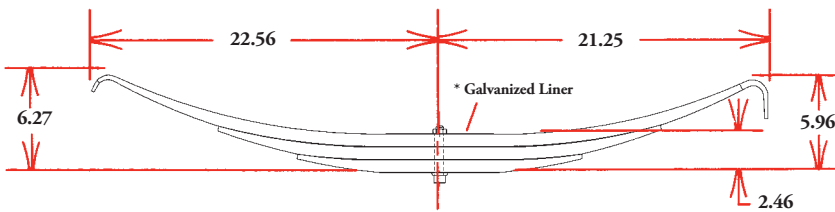

365-00 High Arch, 3 Leaf H.D.

GAWR 25,000 lbs.

Weight 65 lbs.

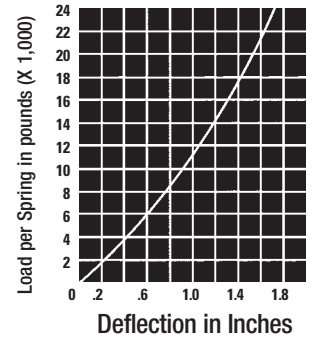
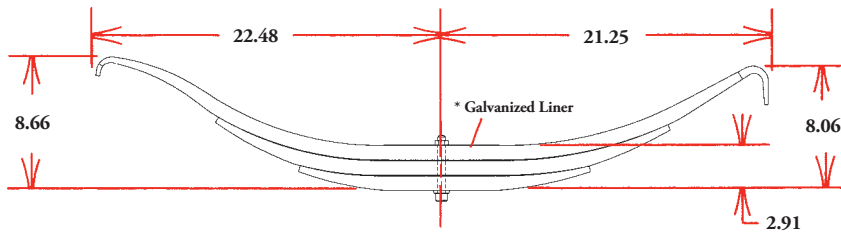

* A galvanized liner is required on the tension side of each plate on single, two and three leaf springs. On single leaf springs the spring liner is shipped loose by Hutchens.

Spring Appendix

365-01 Low Arch, 3 Leaf H.D.

GAWR 25,000 lbs.

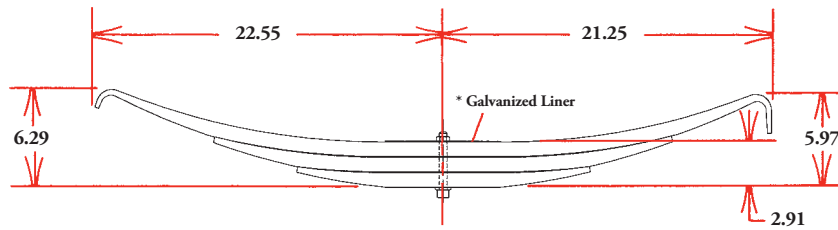

Weight 65 lbs.

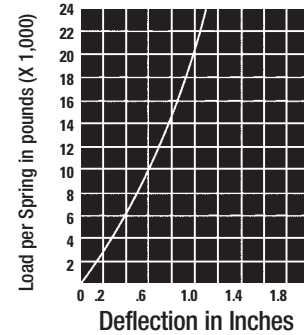

751-01 Low Arch, 7 Leaf

GAWR 22,400 lbs.

49" Axle Centers. Tandem & Multi-Axle Configurations. All Positions.
Front Axle Hook to Rear, Remaining Axles Hook Forward.

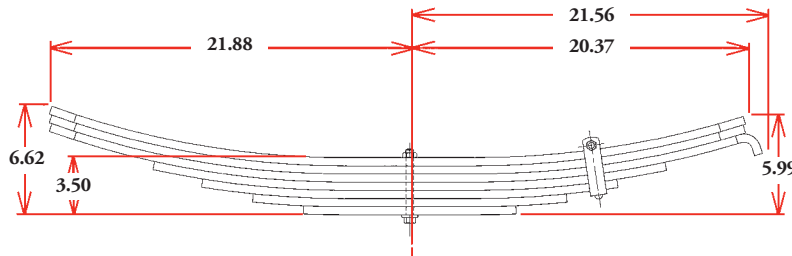

Weight 92 lbs.

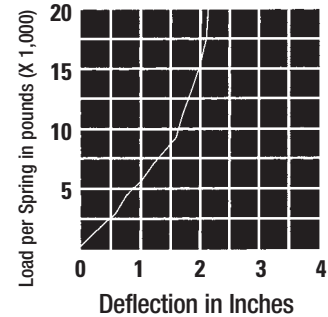

751-05 High Arch, 7 Leaf

GAWR 22,400 lbs.

49" Axle Centers. Tandem & Multi-Axle Configurations. Front & Rear Spring Only.
Hook in Rockers.

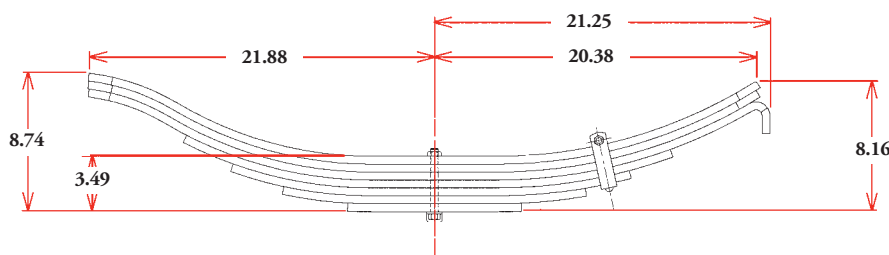

Weight 93 lbs.

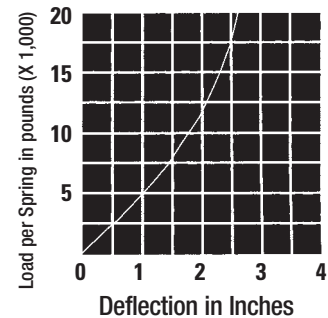

* A galvanized liner is required on the tension side of each plate on single, two and three leaf springs. On single leaf springs the spring liner is shipped loose by Hutchens.

751-06 High Arch, 7 Leaf

Single Axle, Tandem & Multi-Axle Widespread Configurations. All Positions.
Hook to Rear on All Axles.

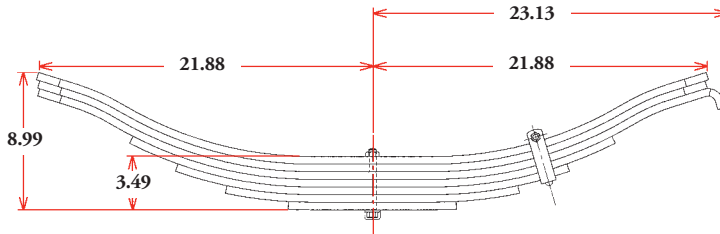

GAWR 22,400 lbs.

Weight 96 lbs.

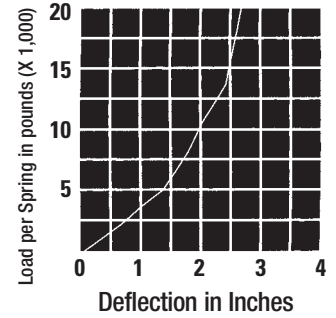

751-08 High arch, 7 Leaf

49" Axle Centers. Middle Spring for Multi-Axle Configurations. Long Hook to Rear.

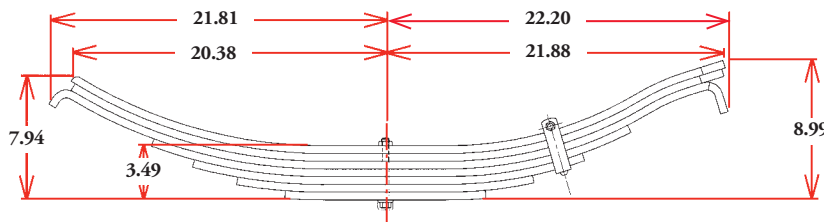

GAWR 22,400 lbs.

Weight 94 lbs.

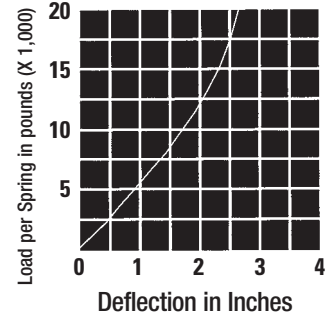

752-01 Low Arch, 8 Leaf H.D.

49" Axle Centers. Tandem & Multi-Axle Configurations. All Positions.
Front Axle Hook to Rear, Remaining Axles Hook Forward.

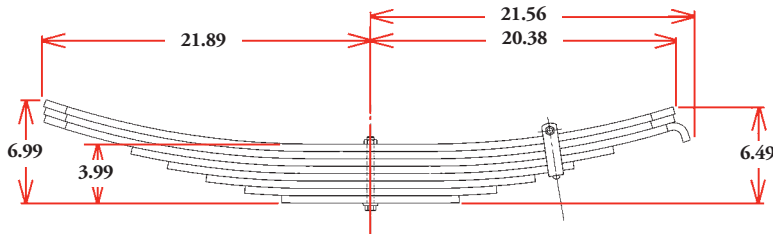

GAWR 25,000 lbs.

Weight 100 lbs.

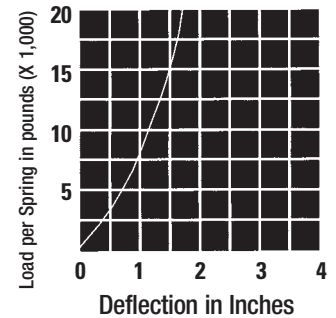

* A galvanized liner is required on the tension side of each plate on single, two and three leaf springs. On single leaf springs the spring liner is shipped loose by Hutchens.

Spring Appendix

752-02 Low Arch, 8 Leaf H.D.

Widespread Tandem & Multi-Axle Configurations. All Positions. Hook to Rear All Axles.

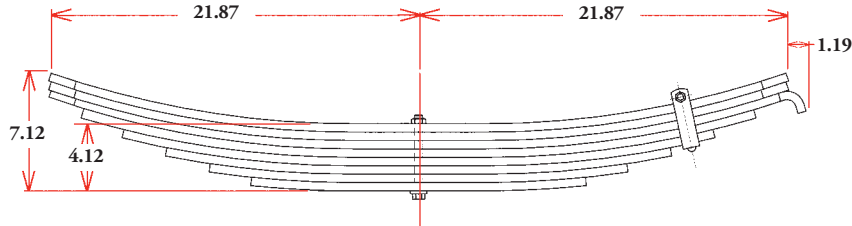

GAWR 25,000 lbs.

Weight 103 lbs.

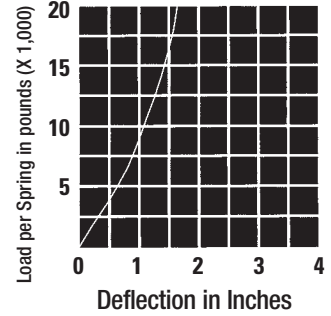

752-05 High Arch, 8 Leaf H.D.

49" Axle Centers. Tandem & Multi-Axle Configurations. Front & Rear Spring Only. Hook in Rockers.

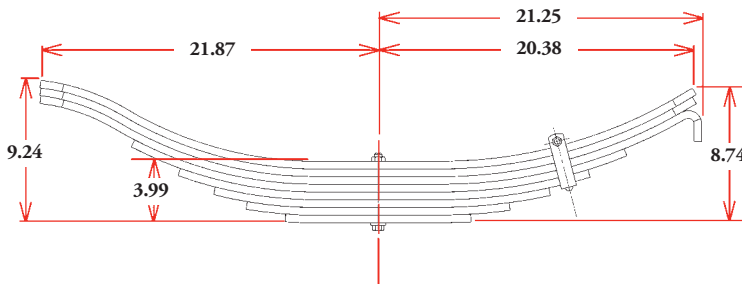

GAWR 25,000 lbs.

Weight 102 lbs.

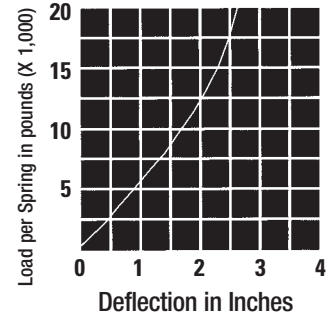

752-06 High Arch, 8 Leaf H.D.

Single Axle, Tandem & Multi-Axle Widespread Configurations. All Positions. Hook to Rear on All Axles.

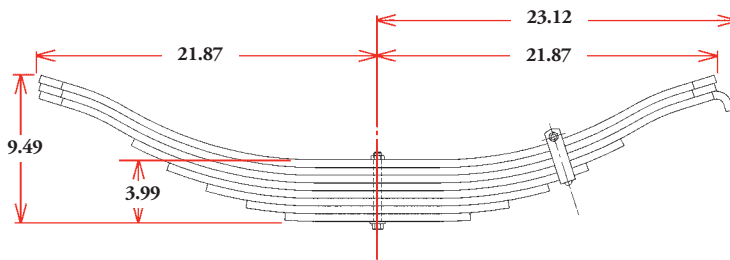

GAWR 25,000 lbs.

Weight 104 lbs.

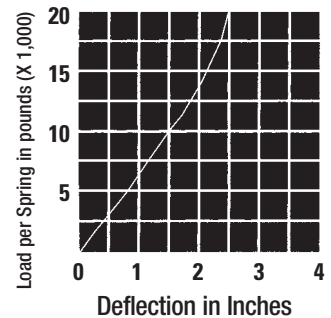

752-07 High Arch, 8 Leaf H.D.

49" Axle Centers. Middle Spring for Multi-Axles Configurations. Long Hook to Rear.

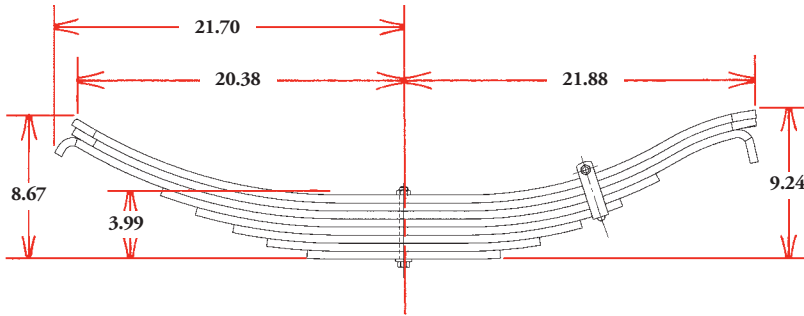

GAWR 25,000 lbs.

Weight 102 lbs.

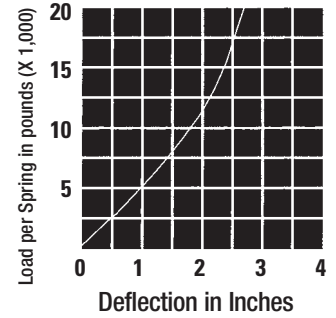

11179-00 Low Arch, 9 Leaf H.D.

49" Axle Centers. Tandem & Multi-Axle Configurations. All Positions. Front Axle Hook to Rear, Remaining Axles Hook Forward.

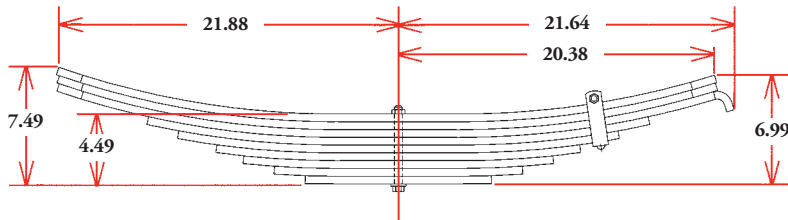

GAWR 25,000 lbs.

Weight 110 lbs.

Deflection
Information
Not
Available

11180-00 Low Arch, 9 Leaf H.D.

Widespread Tandem & Multi-Axle Configurations. All Positions. Hook to Rear All Axles.

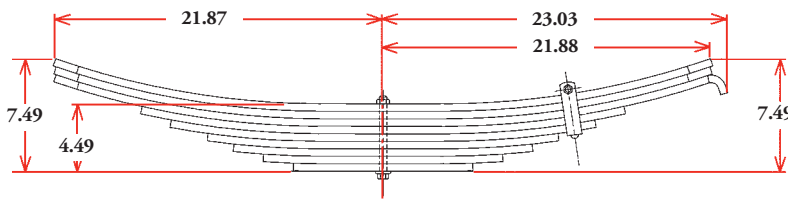

GAWR 25,000 lbs.

Weight 111 lbs.

Deflection
Information
Not
Available

Spring Appendix

16710-01 Medium Arch, 2 Leaf, 2 Stage

Single & Tandem Axle, All Axle Centers – Hook in Rockers. Multi-Axle 49" Axle Centers Only – Hook to Rear on First Axle, Hook Forward on Remaining Axles. Widespread Multi-Axles Front & Rear Axle Only – Hook in Rockers.

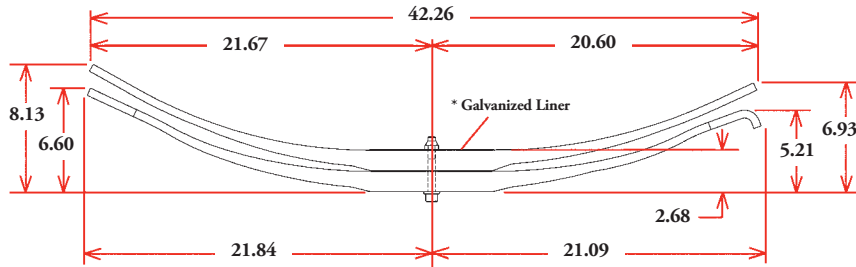

GAWR 22,400 lbs.

Weight 59 lbs.

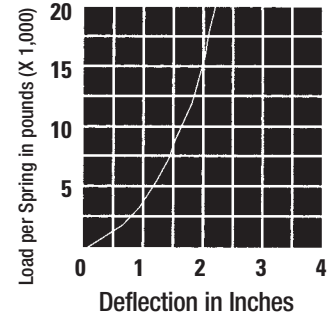

17882-01 Medium Arch, 2 Leaf, 2 Stage

Middle Spring for Multi-Axle Widespreads.

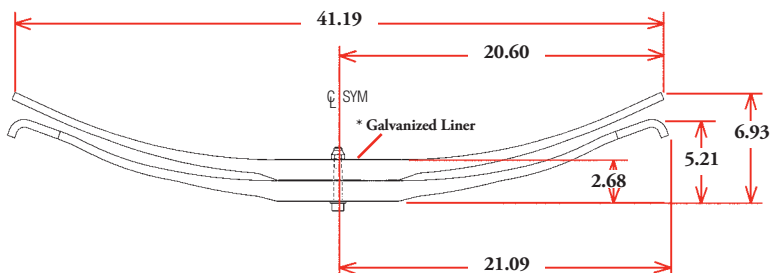

GAWR 22,400 lbs.

Weight 59 lbs.

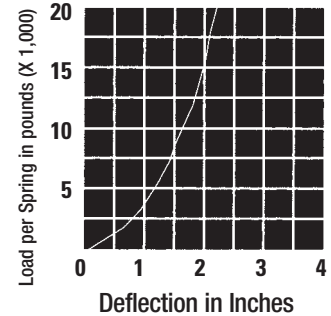

16316-01 Low Arch, FRP Composite

This Spring is Symmetrical and May Be Positioned With Either End to the Rear.

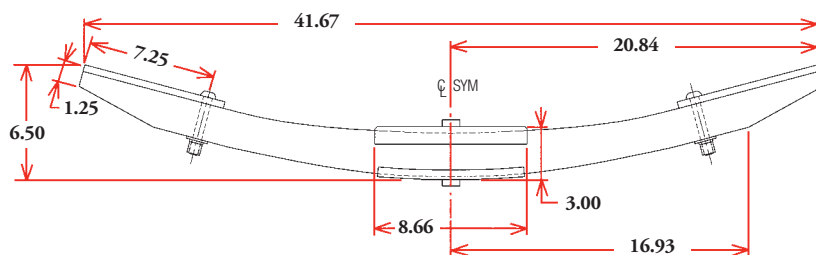

GAWR 24,000 lbs.

Weight 24 lbs.

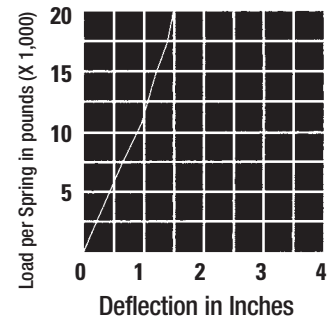

* A galvanized liner is required on the tension side of each plate on single, two and three leaf springs. On single leaf springs the spring liner is shipped loose by Hutchens.

24784-01 High Arch, 3 Leaf Light Duty

GAWR 15,000 lbs.

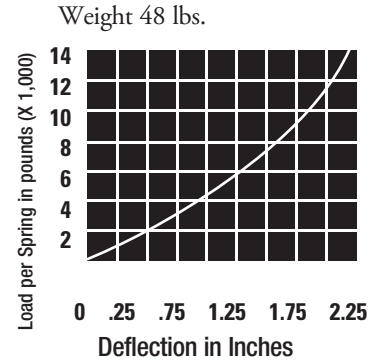
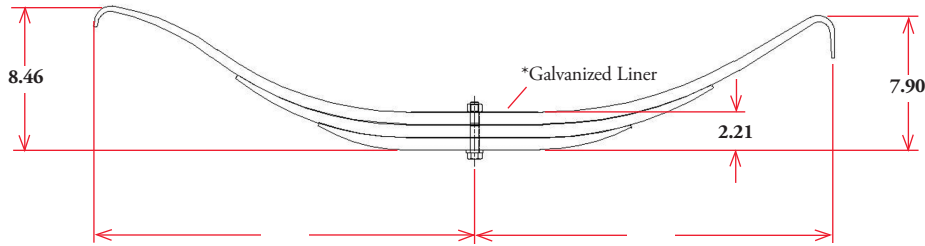

11455

Tri-Axle Suspension

11436-00 6 Leaf, 11455 Tri-Axle

GAWR 20,000 lbs.

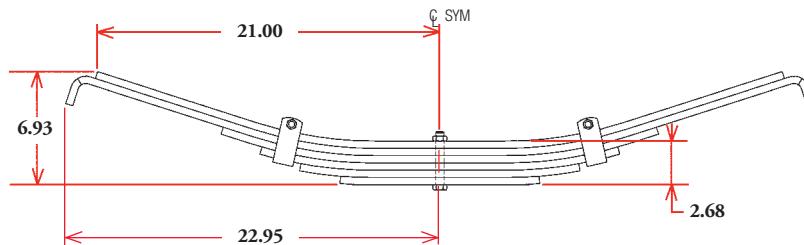

Weight 87 lbs.

22429-01 8 Leaf, 11455 Tri-Axle

GAWR 25,000 lbs.

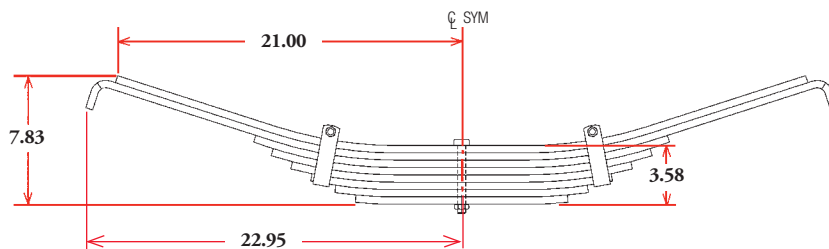

Weight 105 lbs.

* A galvanized liner is required on the tension side of each plate on single, two and three leaf springs. On single leaf springs the spring liner is shipped loose by Hutchens.



Advancing the Practical Application of Suspension Technology

Springfield, MO ■ (800) 654-8824 ■ (417) 862-5012
Fax (417) 862-2317 ■ www.hutchensindustries.com